

OIL MIST DETECTION SYSTEMS VISATRON®

VN115/87^{plus}

VN115/87^{plus}EX 

VN116/87^{plus}

VN215/87^{plus}

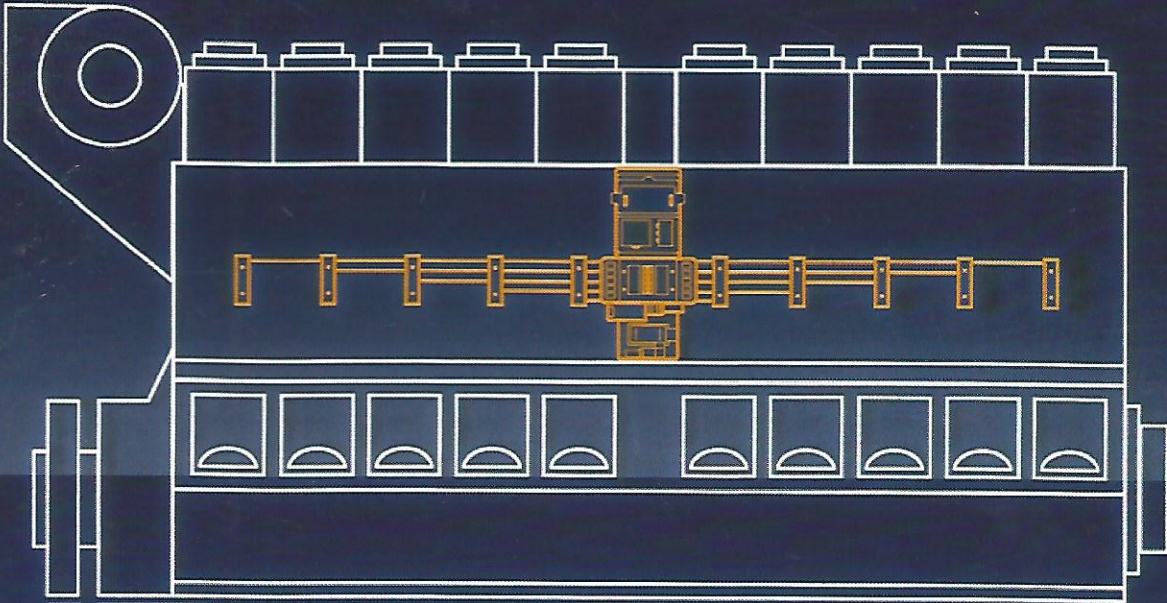

Technical Information



SYSTEM FEATURES:

- Over 54.000 engines well protected by VISATRON®
- Automatic opacity adaptation to engine in normal operation - False Alarm-Free System even under frequent changes in engine load and rpm
- Extremely low maintenance cost - designed for engine lifetime
- Active dirt protection of optics by clean air - only available from SCHALLER AUTOMATION
- Designed for vibrations beyond classification rules
- Class approval of 11 Classification Societies

VISATRON® TECHNICAL DATA

A COMPONENT OF THE DIEMOS-SYSTEM

FUNCTION DESCRIPTION

All VISATRON® - devices continuously draw the atmosphere from compartments of the crankcase by means of a suction system. The suction required is generated by the Venturi effect, fed by compressed air. The sample flow, consisting of air from the crankcase compartments, is guided through a light beam of infrared light for measuring opacity. The level of oil mist is measured by the absorption of the infrared light.

Opacity (in%) is used as the dimensional unit of the turbidity; 100% Opacity means total light absorption, and 0% opacity no absorption.

DESIGN

All Oil Mist Detectors of the VISATRON® family are designed to last the lifetime of the engine.

The measuring heads containing the optical system for opacity measurement, as well as the electronics, are designed to be interchangeable with the older VN/87 series, produced for almost 25 years.

The air jet pump, the connector plug, the pipe connector box (VN115/87^{plus}) resp. the valve box (VN116/87^{plus} and VN 215/87^{plus}) and the shock-absorbing mounting plate for the actual measuring head are mounted on a solid base plate.

The VN87^{plus} series offers the following standard features:

- Scavenging air chambers are not supplied with air from the engine atmosphere, but with fresh pressurized air so that the optical system is well protected against contamination and stays clean.
Also the filters stay clean for a longer period.
- A measuring head heating unit prevents possible condensation, limiting the danger of false alarms due to humidity around the optical system.
- An RS 485 interface permits the connection of the VN87^{plus} series to a remote monitoring unit, alternatively the system may be connected via a 4-20mA connection.
- A separate pre-alarm relay, activated at 70% opacity of main alarm level, will be activated before an engine stop will be triggered based on a high concentration of oil mist (endangering the engine).

All VISATRON® Oil Mist Detectors are equipped with 3 Relay outputs:

- System ready
- Pre-Alarm
- High Oil Mist Alarm (also called Main Alarm)

APPLICATION OF THE DIFFERENT VISATRON® DEVICES AND SUCTION SYSTEMS

VISATRON® VN115/87^{plus} and VN115/87^{plus}EX

- Basic design, suitable for the monitoring of trunk piston diesel engines with in-line and V-type engines running at medium and high speed.
- In the event of dangerous oil mist generation, there is an alarm signal via the alarm relay for high oil mist. There is no indication of the oil mist source location.

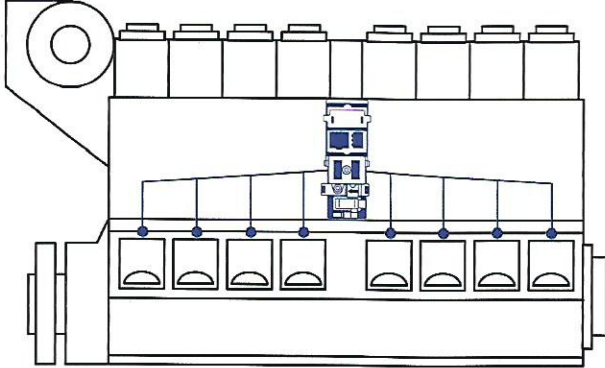

VISATRON® VN116/87^{plus}

- Suitable for the monitoring of trunk piston diesel engines with in-line and V-type engines running at medium and high speed.
- Oil Mist Detection via a pipe sampling system and an indication which side of the engine the oil mist level has risen to dangerous levels.
- If localization of the high oil mist is required, the VN116/87 can replace the VN115/87 with minimal modification.

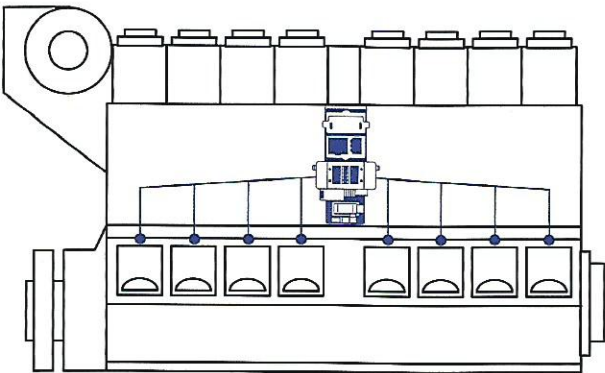

VISATRON® VN215/87^{plus}

- Suitable for the monitoring of crosshead engines running at medium and slow speed, because the oil mist spreads out from the damaged compartment more slowly than in the case of trunk piston engines.
- Damage detection through the individual compartment suction pipe system, displaying the relevant compartment giving the alarm.

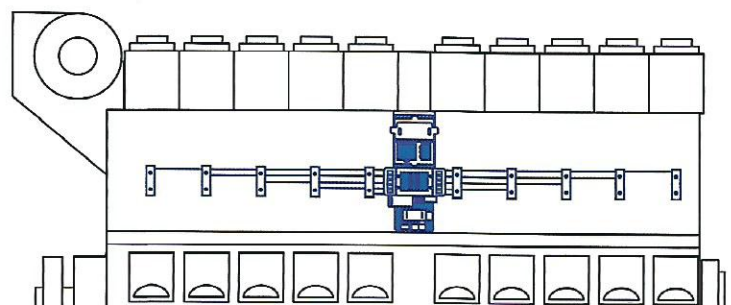
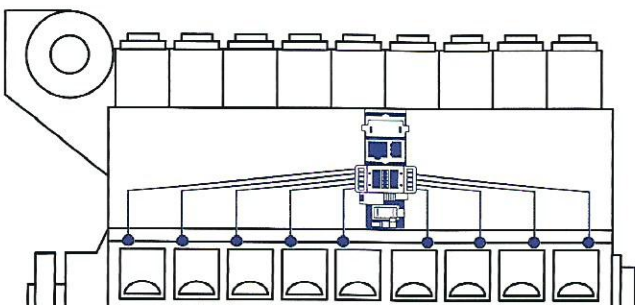

THE DIFFERENT VISATRONS®

VISATRON® VN115/87^{plus}EX

- Suitable for the monitoring of 4-stroke Diesel, Gas- and Dual Fuel engines inline or V-type engine arrangements
- ATEX-certified for crankcase environment according to II (2G) [Ex op is II B T 4 G b]

- In the event of dangerous oil mist generation, there is an alarm signal via the alarm relay for high oil mist. There is no indication of the oil mist source location.

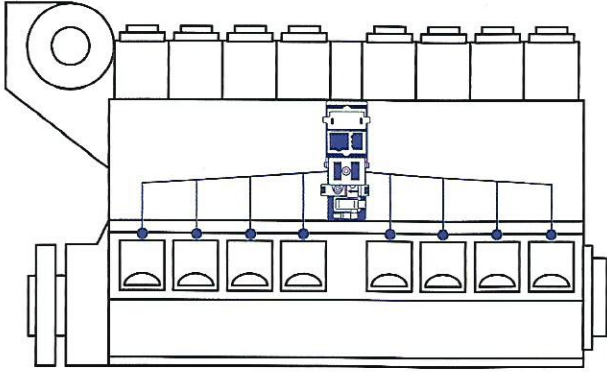

The detection of damage takes place through a header pipe sampling system without localisation of the point of damage. The mixture of atmosphere from the crankcase passes from all individual compartments via the header

pipe through the detector's pipe connector box into the opacity measurement path in the housing of the measuring head. The alarm threshold can be set to 4 levels.

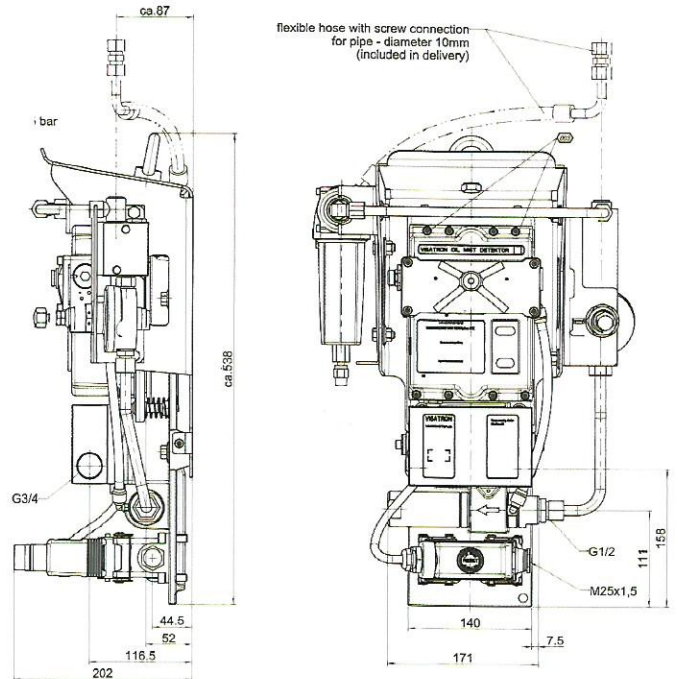
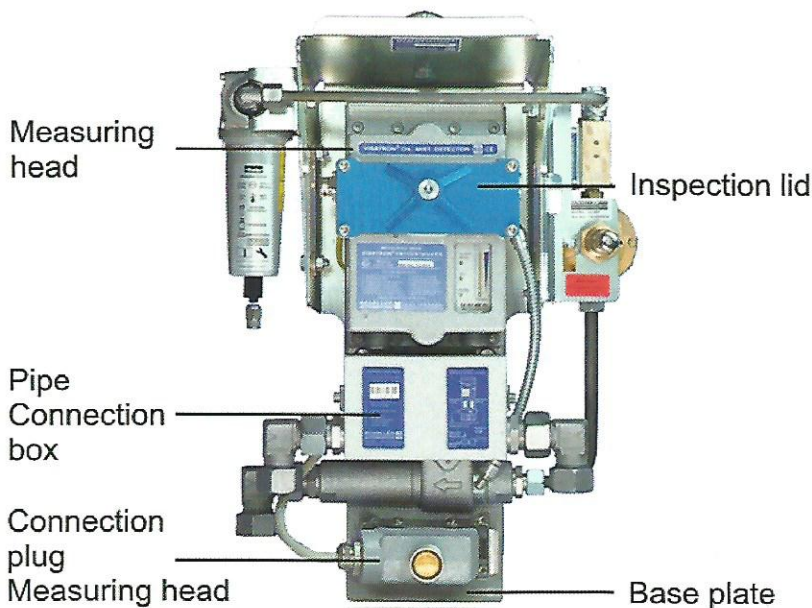

VISATRON® VN115/87^{plus}, VISATRON® VN115/87^{plus} EX and VISATRON® VN116/87^{plus}

2 header pipes (22 x 2 mm) with thinner branch pipes (10 x 2 mm) to the crankcase compartments, max. length 9m.

VISATRON® VN215/87^{plus}

Individual pipes (14 x 2 mm) from each compartment to the OMD, max. length 9m.

The maximum number of sampling points for both systems (header pipe and individual) =10
Suction pressure measured against atmospheric pressure 60 mmWC.

SENSITIVITY

VISATRON® VN115/87^{plus}

Alarm threshold 2% *opacity (see brief description of the VN 115/87^{plus}), adjustable in 4 levels from 0.5% to 25% Opacity.

VISATRON® VN116/87^{plus} and VISATRON® VN215/87^{plus}

Damage check - start threshold 0.24% *opacity (see brief description of the VN 116/87^{plus}), adjustable in 4 levels from 0.16% to 0.55% opacity.
Differential alarm threshold 0.49% *opacity (see brief description of the VN 116/87^{plus}), adjustable in 4 levels from 0.33% to 1.1% opacity. Safety alarm threshold 2.44% *opacity, adjustable in 4 levels from 1.6% to 5.5% opacity.
*Factory setting

POWER SUPPLY VISATRON® ELECTRIC POWER SUPPLY

Voltage

24 V DC - 25/+ 30%, 24 V battery or power supply unit

Note

In case of battery operation, provide a direct power supply from the battery terminals directly to the VISATRON® device!

Current consumption

max. 2A

DRIVE AIR FOR THE SUCTION SYSTEM VISATRON®

Vacuum measured against the atmosphere of 60 mmWC. The measurement is performed with a U-pipe manometer in the measuring head. The U-pipe manometer is a component of the service box (see accessories).

Air consumption max. 2,5 N m³/h (m³ at atmospheric pressure).
The drive air can be taken from the pneumatic engine control system or from the starting air system.

SIGNAL OUTPUTS AND DISPLAYS HIGH OIL MIST ALARM

Adjustment range for the sensitivity

can be set to 4 levels

Remote signalling

Relay with 2 potential-free switch-over contacts.

Contact load

max. 60V DC, 1 A, 60 W

Wire-break protection

bridging each n.o. contacts with 33 K ohm resistor.

VISATRON® TECHNICAL DATA

PRE-ALARM

Factory Pre-Set	to 70% of the main alarm threshold, not changeable
Remote signalling	relay with potential-free contact, opens for a pre-alarm
Contact load	max. 60V AC, 2 A , 120 VA / max. 60 V DC, 2A, 60W
Displayed on device	Blinking red alarm relay

READY, INDICATION OF DEVICE IN OPERATION

Remote signalling	Relay with potential-free switch-over contact, when the device is functioning trouble free
Contact load	max. 60V AC, 2 A, 120 VA/max. 60V DC, 2 A, 60W
Displayed on device	green Ready-LED on when the device is functioning troublefree

OPACITY DISPLAY

Remote signalling	By a remote indicator, through the RS485 interface or 4-20 mA
Displayed on device	Set of 14 LED's displaying the opacity relative to the alarm threshold in 14 steps, i.e. the main alarm is triggered when the upper LED is reached.

CABLE CONNECTIONS

M25 x 1.5 screwed connections for the cable connection of the relay contacts and power supply

MECHANICAL DATA / TEMPERATURE

Housing and base plate	Cast aluminium. Support plate for the measuring head: stainless steel plate with anti vibration suspension
All surfaces	lacquered, RAL 7035
Springs, bolts etc.	Stainless steel
Rubber parts for vibration reduction	Oil resistant. Built-in vibration reduction for the electronic part
System of Protection	IP 54
Operating range	0°C to 70°C
Storage temperature	-25°C to +80°C
VN115/87 ^{plus} net weight	7.5 kg
Gross with special packing	12.5 kg
VN116/87 ^{plus} and VN215/87 ^{plus} net weight	9.4 kg
Gross with special packing	13.5 kg
VN115/87 ^{plus} EX net weight	11.0 kg
Gross with special packing	15.0 kg

Comprehensive investigations on different types of engines have made clear that the sampling points for the oil mist have to be placed in the interior of the crankcase at points where the highest possible concentration of oil mist can be extracted, in the shortest time possible. The concentration of extracted oil mist from the crankcase is an indication of the condition of the crankdrive. It is imperative that accurate information is transmitted as a signal with the greatest possible intensity from the point of oil mist generation, so

that the sensitivity of the Oil Mist Detector doesn't have to be set unnecessarily high. Otherwise, interfering influences are also received and evaluated.

One of the most important requirements for a well-functioning oil mist monitoring system is the absolute necessity of avoiding false alarms. In addition, the way the piping system is installed on the engine is of great importance.

ILLUSTRATION 1

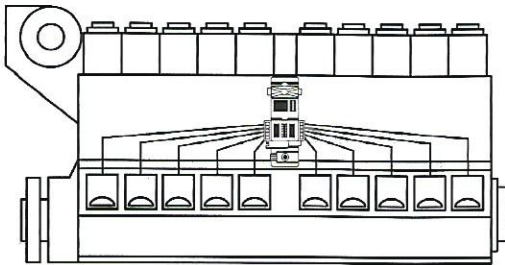

The picture shows the conventional installation of a VISATRON® Oil Mist Detector VN215. The pipes have the necessary slope for the return of the oil that has precipitated from the oil mist. Due to this slope, the pipes require an area of free space extending over the entire length of the engine and part of its height. This prevents obstruction of the crankcase doors and compartments during maintenance work.

ILLUSTRATION 2

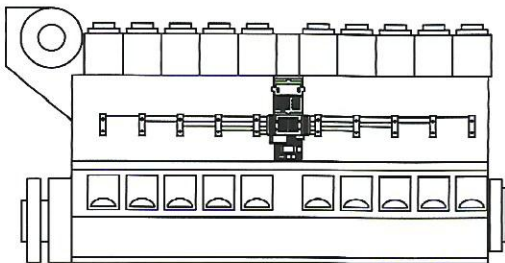

The picture shows, the installation of a VISATRON® Oil Mist Detector, type VN215, with individual compartment suction pipe system consisting of a space-saving siphon block assembly set. The advantage of horizontal pipe installation can be clearly recognised. Oil that precipitates in the suction pipes is led back into the crankcase through the siphon blocks.

ILLUSTRATION 3

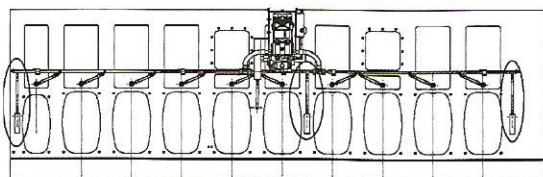

The picture shows a further alternative in tubing arrangement for VN115/87^{plus} and VN116/87^{plus}. To avoid collection of excessive oil in the horizontal tubing system, oil separation units are installed (see marking).

ILLUSTRATION 4

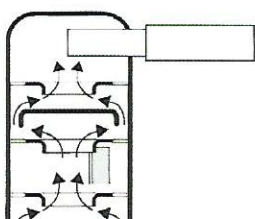

The picture shows the sectional view through a suction head with its maze, which effectively prevents spray oil from getting into the suction pipe system.

VISATRON® ASSEMBLY SYSTEM

ILLUSTRATION 5

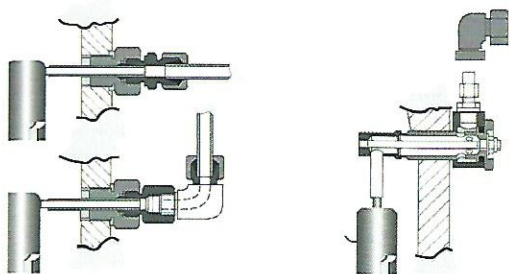

The engine wall connections join the suction heads located in the crankcase compartment and the suction pipes on the outside, and are available in various designs with different metric or pipe thread sizes. Maze suction heads with different pipe lengths can be installed (see Illustration 4). The engine wall connections can be used for conventional suction pipe systems or also in connection with VISATRON® siphon blocks.

ILLUSTRATION 6

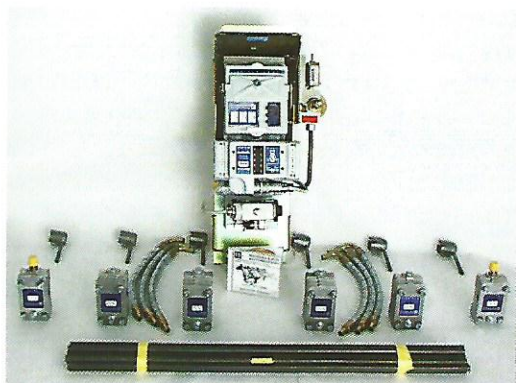

SCHALLER AUTOMATION has developed various types of VISATRON® assembly units in order to adapt to the installation conditions on almost every engine design. The assembly units consist of a VISATRON® OMD, a specific engine adapted bracket, available for crosshead and trunk piston engines, an integrated protective cover, an air pressure regulation unit, fixtures and fittings for the compressed air supply. The assembly unit is a component of the VISATRON® assembly set. SCHALLER AUTOMATION supplies special, ready-made modular assembly sets for VISATRON® Oil Mist Detectors, for a variety of engine types from worldwide manufacturers. An Oil Mist Detection system for a specific engine, (Illustration 6) consists of:

- Pipe connections, either with engine wall connections or siphon blocks
- Ready-made pipes
- All necessary fittings, such as pipe supports and fastening elements

ILLUSTRATION 7



SCHALLER AUTOMATION offers a specially designed service box for the VISATRON® adaptation to the engine for quick assembly that is available to all our clients. Service Box (Illus. 7) on request. The service box contains all replacement parts, tools and devices necessary for the initial operation, the repair and the fixing of malfunctions. The amount of replacement parts in the service box is sufficient for an operating period of 1 year.

ILLUSTRATION 8



Pressure regulation unit (Illus. 8). The pressure regulation unit consists of a pressure regulator and a throttle block with an integrated air filter. The throttle block ensures that the drive air pressure in the VISATRON® Oil Mist Detector does not increase to an excessively high level if the pressure regulator fails. (e.g. failure of diaphragm) The

OIL MIST DETECTION EFFICIENCY APPROVAL**SYSTEM FEATURES**

The OMDEA is designed to find the highest possible OMD sensitivity in the shortest possible time with the lowest possible false alarm levels, adapted to specific engine types.

With the release of the Unified Requirements (UR) M 10 ('Protection of internal combustion engines against crankcase explosions') and M 67 ('Type Testing Procedure for Crankcase Oil Mist Detection and Alarm Equipment') in 2006, IACS, for the first time, requested similar tests via Classification Societies for new engine types and vessel new builds.



SCHALLER AUTOMATION offers damage simulation, with our in-house simulator, to integrate the OMD system in the best possible manner to specific engine types.



Download your OMDEA Brochure here

Oil Mist Generators providing real oil mist in order to simulate e.g. acute bearing damage in a running engine.

